

Quick Installation Guide

MOBOTIX S74

© 2020 MOBOTIX AG



Table of Contents

Table of Contents	2
Support	4
Imprint	5
Safety Warnings	6
Legal Notes	7
FCC Disclaimer	8
Notes on System Security	9
Cleaning the Camera and Lenses	10
Drilling Template	11
mx_DT_S74_de-en-fr	12
Delivered Parts and Dimensions	13
MOBOTIX S74: Scope of Delivery	14
Mounting Supplies: Scope of Delivery	15
PTMount: Scope of Delivery	16
PTMount-Thermal: Scope of Delivery	17
MOBOTIX S74 – Dimensions	18
PTMount – Dimensions	18
PTMount-Thermal – Dimensions	19
Technical Specifications	21
Mounting	29
Before Mounting the Camera	30
Protective Measures	31
Installing Sensor Modules	32
Without Mounts	33
With PTMount	35
With PTMount-Thermal	41

Installing the RJ45 Interface Board	45
Mounting the Camera	46
Connecting Sensor Modules	47
Sensor Module Combinations	49
Connecting the Camera to the Network	50
Operating the Camera	53
Getting Started	53
Boot Options of the Camera	54
Network Settings	57
Focusing the TELE 15° Sensor Module	63
Camera Software in the Browser	67
Basic Settings	68
Configuring Sensor Modules	69

Support

If you need technical support, please contact your MOBOTIX dealer. If your dealer cannot help you, he will contact the support channel to get an answer for you as quickly as possible.

If you have internet access, you can open the MOBOTIX help desk to find additional information and software updates. Please visit:

www.mobotix.com > [Support](#) > [Help Desk](#)



Imprint

This document is part of the camera manufactured by MOBOTIX AG (called manufacturer in the following); the document describes how to use and to configure the camera and its components.

Subject to change without notice.

Copyright Information

This document is protected by copyright. Passing on information to others is not permitted without the prior written consent of the manufacturer. Violations will be subject to criminal punishment.

Patent and Copy Protection

All rights reserved. Trademarks or registered trademarks belong to the corresponding owners.

Address

MOBOTIX AG

Kaiserstrasse

67722 Langmeil

Germany

Phone: +49 6302 9816-103

E-Mail: sales@mobotix.com

Internet: www.mobotix.com

Safety Warnings

- This product must not be used in locations exposed to the dangers of explosion.
- Make sure that you install this product as outlined in this document. A faulty installation can damage the camera!
- When installing this product, make sure that you are only using genuine MOBOTIX parts and MOBOTIX connection cables. Only install this product on suitable, solid materials that provide for a sturdy installation of the fixing elements used.

Electrical installation: Electrical systems and equipment may only be installed, modified and maintained by a qualified electrician or under the direction and supervision of a qualified electrician in accordance with the applicable electrical guidelines. Make sure to properly set up all electrical connections.

Electrical surges: MOBOTIX cameras are protected against the effects of small electrical surges by numerous measures. These measures, however, cannot prevent the camera from being damaged when stronger electrical surges occur. Special care should be taken when installing the camera outside of buildings to ensure proper protection against lightning, since this also protects the building and the whole network infrastructure.

Hot temperatures: The S74 must not be installed within the reach of persons. Due to the high power of the processor and depending on the operating environment, the camera housing can reach **high temperatures**. This does not harm the camera in any way.

Power off before opening the camera: Make sure the power supply to the camera is disconnected before opening the camera housing (e.g., when exchanging the SD card or connecting wires inside the housing).

Network security: MOBOTIX products include all of the necessary configuration options for operation in Ethernet networks in compliance with data protection laws. The operator is responsible for the data protection concept across the entire system. The basic settings required to prevent misuse can be configured in the software and are password-protected. This prevents unauthorized parties from accessing these settings.

Legal Notes

Special Export Regulations!

Cameras with thermal image sensors ("thermal cameras") are subject to the special export regulations of the U.S.A. and including the ITAR (International Traffic in Arms Regulation):

- According to the currently applicable export regulations of the U.S.A. and the ITAR, cameras with thermal image sensors or parts thereof must not be exported to countries embargoed by the U.S.A., except if a special permit can be presented. At present, this applies to the following countries: Syria, Iran, Cuba, North Korea, Sudan and Krim. The same export ban applies to all persons and institutions listed in "The Denied Persons List" (see www.bis.doc.gov, "Policy Guidance > Lists of Parties of Concern"; <https://www.treasury.gov/resource-center/sanctions/sdn-list/pages/default.aspx>).
- Under no circumstances must the camera itself or its thermal image sensors be used in the design, the development or in the production of nuclear, biological or chemical weapons or in the weapons themselves.

Legal Aspects of Video and Sound Recording

You must comply with all data protection regulations for video and sound monitoring when using MOBOTIX AG products. Depending on national laws and the installation location of the S74, the recording of video and sound data may be subject to special documentation or it may be prohibited. All users of MOBOTIX products are therefore required to familiarize themselves with all applicable regulations and to comply with these laws. MOBOTIX AG is not liable for any illegal use of its products.

Declaration of Conformity

The products of MOBOTIX AG are certified according to the applicable regulations of the EC and other countries. You can find the declarations of conformity for the products of MOBOTIX AG on www.mobotix.com under Support > Download Center > Certificates & Declarations of Conformity.

RoHS Declaration

The products of MOBOTIX AG are in full compliance with European Unions Restrictions of the Use of Certain Hazardous Substances in Electrical and Electronic Equipment (RoHS Directive 2011/65/EC) as far as they are subject to these regulations (for the RoHS Declaration of MOBOTIX, please see www.mobotix.com, Support > Download Center > Documentation > Brochures & Guides > Certificates).

Disposal

Electrical and electronic products contain many valuable materials. For this reason, we recommend that you dispose of MOBOTIX products at the end of their service life in accordance with all legal requirements and regulations (or deposit these products at a municipal collection center). MOBOTIX products must not be disposed of in household waste! If the product contains a battery, please dispose of the battery separately (the

corresponding product manuals contain specific directions if the product contains a battery).

Disclaimer

MOBOTIX AG does not assume any responsibility for damages, which are the result of improper use or failure to comply to the manuals or the applicable rules and regulations. Our General Terms and Conditions apply. You can download the current version of the **General Terms and Conditions** from our website at www.mobotix.com by clicking on the corresponding link at the bottom of every page.

FCC Disclaimer

NOTE:

This equipment has been tested and found to comply with the limits for a Class A digital device, pursuant to part 15 of the FCC Rules. These limits are designed to provide reasonable protection against harmful interference when the equipment is operated in a commercial environment. This equipment generates, uses, and can radiate radio frequency energy and, if not installed and used in accordance with the instruction manual, may cause harmful interference to radio communications. Operation of this equipment in a residential area is likely to cause harmful interference in which case the user will be required to correct the interference at his own expense.

Notes on System Security

To protect the camera against security risks in data technology, the following measures are recommended after the installation has been completed:

MxManagementCenter:

- Menu **View > Wizards & Tools > Secure System:**
 - **Change camera factory default password:** ✓
 - **Enable encrypted HTTPS:** ✓
 - **Disable public access:** ✓
 - **User Management** (for all users):
 - **Force Complex Password:** ✓
 - **Log out on Inactivity:** After 5 min

User interface of the camera in the browser:

- **Admin Menu > Network Setup > Web Server:**
 - **Enable MxWeb:** –
 - **Enable intrusion detection:** ✓
 - **Notification threshold:** 10
 - **Timeout:** 60 minutes
 - **Block IP Address:** ✓

For more information on this new feature, please read the «Cyber Protection Guide» on www.mobotix.com (under Support > Download Center > Documentation > Brochures & Guides > Cyber Security).

Cleaning the Camera and Lenses

Clean the camera housing using a mild alcohol-free detergent without abrasive particles.

If the lens is dirty from the installation process, clean the lens using a lint-free cotton cloth. Make sure that the lens is still in focus after cleaning and adjust the lens' focus if required.

To protect the lens protection glass, only use the supplied mounting supplies (see [MOBOTIX S74: Scope of Delivery, p. 14](#)).

Cleaning the lens protection glass

- Use the wide end of the gray module wrench (M.1) to remove/install the lens protection glass. The narrow side of the wrench is used to adjust the sharpness (focal length) of the tele lenses.
- You should clean the lens protection glasses and domes regularly using a clean, lint-free cotton cloth. If the dirt is more persistent, add a mild alcohol-free detergent without abrasive particles.
- Make sure you instruct cleaning personnel on how to clean the camera.

Drilling Template

Open this file in a PDF viewer (e.g. Adobe Reader) and print the file **without scaling (original size)**.

Note

You can download the drilling template from the MOBOTIX website:

www.mobotix.com > [Support](#) > [Download Center](#) > [Marketing & Documentation](#) > [Drilling Templates](#).

Attention!

Always print or copy at 100% of the original size!

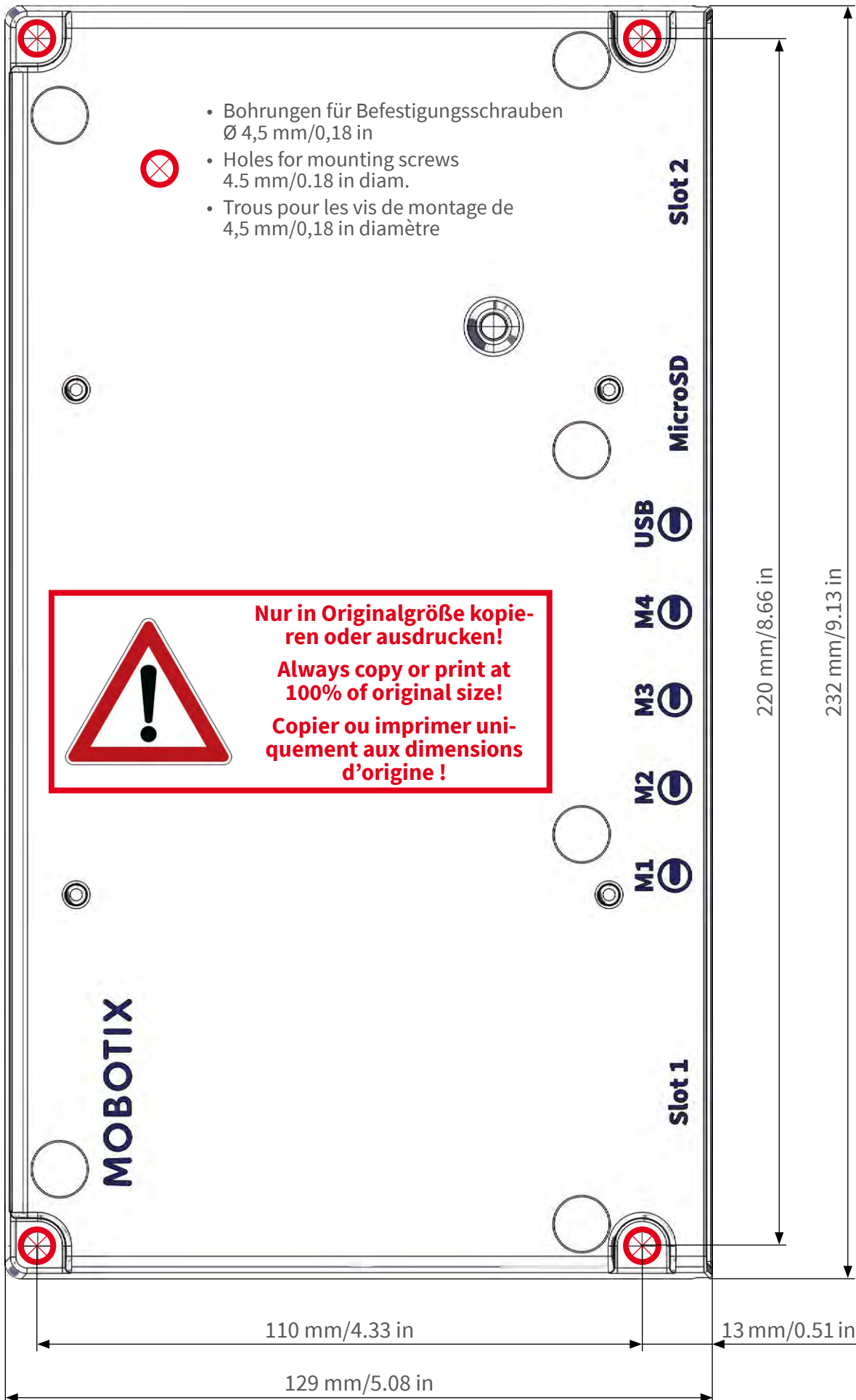

MOBOTIX, le logo MX, MxPEG et MxActivitySensor sont des marques déposées de MOBOTIX AG dans l'Union européenne, aux États-Unis et dans d'autres pays. • Sous réserve de modifications • MOBOTIX décline toute responsabilité concernant les erreurs techniques, les fautes d'impression ou les omissions. • Tous droits réservés. • © MOBOTIX AG 2017

MOBOTIX, the MX logo, MxPEG and MxActivitySensor are trademarks of MOBOTIX AG registered in the European Union, the U.S.A., and other countries • information subject to change without notice • MOBOTIX does not assume any liability for technical or editorial errors or omissions contained herein • All rights reserved. • © MOBOTIX AG 2017

MOBOTIX, das MX Logo, MxPEG und MxActivitySensor sind in der Europäischen Union, den USA und in anderen Ländern eingetragene Marken der MOBOTIX AG • Änderungen vorbehalten • MOBOTIX übernimmt keine Haftung für technische Fehler, Druckfehler oder Auslassungen • Alle Rechte vorbehalten • © MOBOTIX AG 2017



2

Delivered Parts and Dimensions

MOBOTIX S74: Scope of Delivery

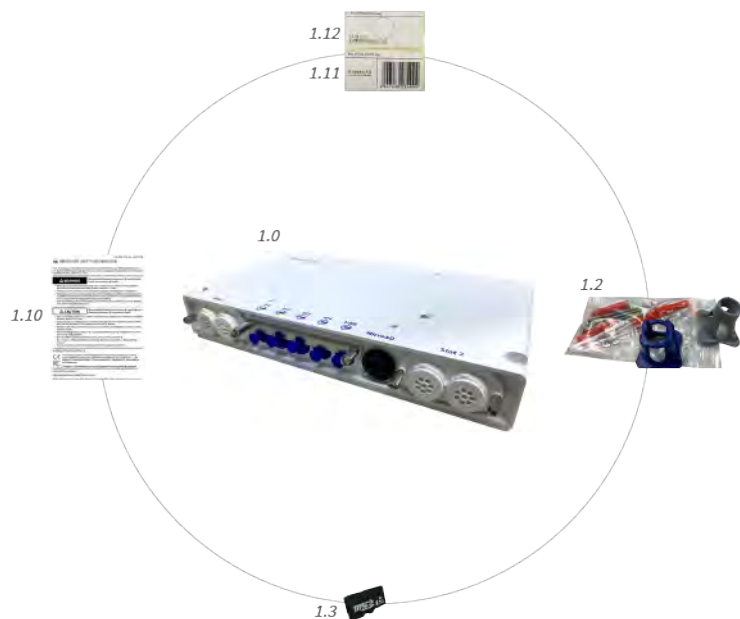

Fig. 1: Scope of delivery S74

Scope of delivery S74 Body		
Item	Count	Description
1.0	1	S74, complete
1.1	1	Important Safety Information
1.2	1	Sticker with IP address of camera
1.3	1	Sticker with EAN number of camera
1.4	1	Mounting supplies (see MOBOTIX S74: Scope of Delivery, p. 14)
1.5	1	SD card 8 GB (installed)

Mounting Supplies: Scope of Delivery

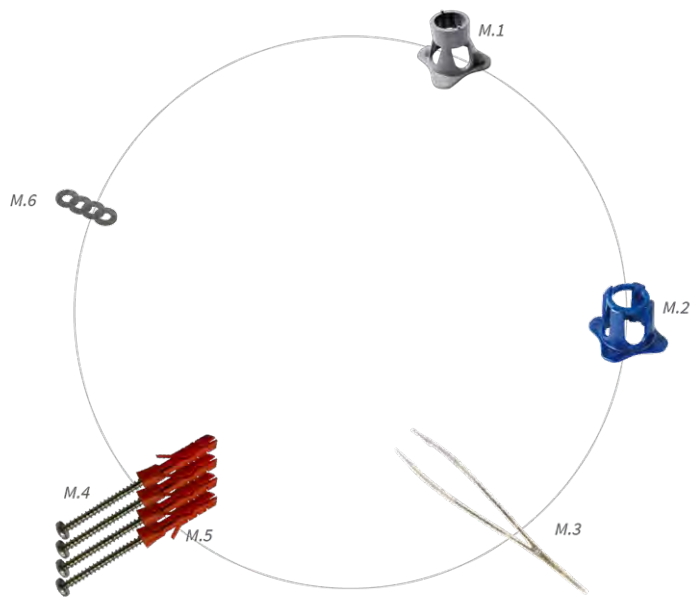

Fig. 2: Scope of Delivery S74 Mounting Supplies

Scope of Delivery S74 Mounting Supplies		
Item	Count	Description
M.1	1	Module wrench (gray)
M.2	1	Lens wrench blue
M.3	1	Tweezers
M.4	4	Wood screw 4.5x60 mm
M.5	4	Dowel S8
M.6	4	Washer

PTMount: Scope of Delivery



Fig. 3: Scope of delivery PTMount

Scope of delivery PTMount		
Item	Count	Description
PM.1	1	Sphere with rotating insert (installed)
PM.2	1	Foot (installed)
PM.3	1	Base plate (installed)
PM.4	1	Swivel ring (installed)
PM.5	1	Sealing
PM.6	4	Washer Ø 4.3 mm, stainless steel
PM.7	4	Wood screw 4x40 mm, stainless steel
PM.8	4	Screw anchor S6
PM.9	1	Allen wrench 2.5 mm

PTMount-Thermal: Scope of Delivery



Fig. 4: Scope of delivery PTMount-Thermal

Scope of delivery PTMount-Thermal		
Item	Count	Description
PM-T.1	1	Sphere with rotating Thermal/Thermal-TR sensor module (installed)
PM-T.2	1	Foot (installed)
PM-T.3	1	Base plate (installed)
PM-T.4	1	Swivel ring (installed)
PM-T.5	1	Sealing
PM-T.6	4	Sensor cable 2 m/6.6 ft (installed)
PM-T.7	4	Washer Ø 4.3 mm, stainless steel
PM-T.8	4	Wood screw 4x40 mm, stainless steel
PM-T.9	1	Screw anchor S6
PM-T.10	1	Allen wrench 2 mm
PM-T.11	1	Allen wrench 2.5 mm

MOBOTIX S74 – Dimensions

Note

You can download the drilling template from the MOBOTIX website: www.mobotix.com > Support > Download Center > Marketing & Documentation > Drilling Templates.

Attention!

Always print or copy at 100% of the original size!

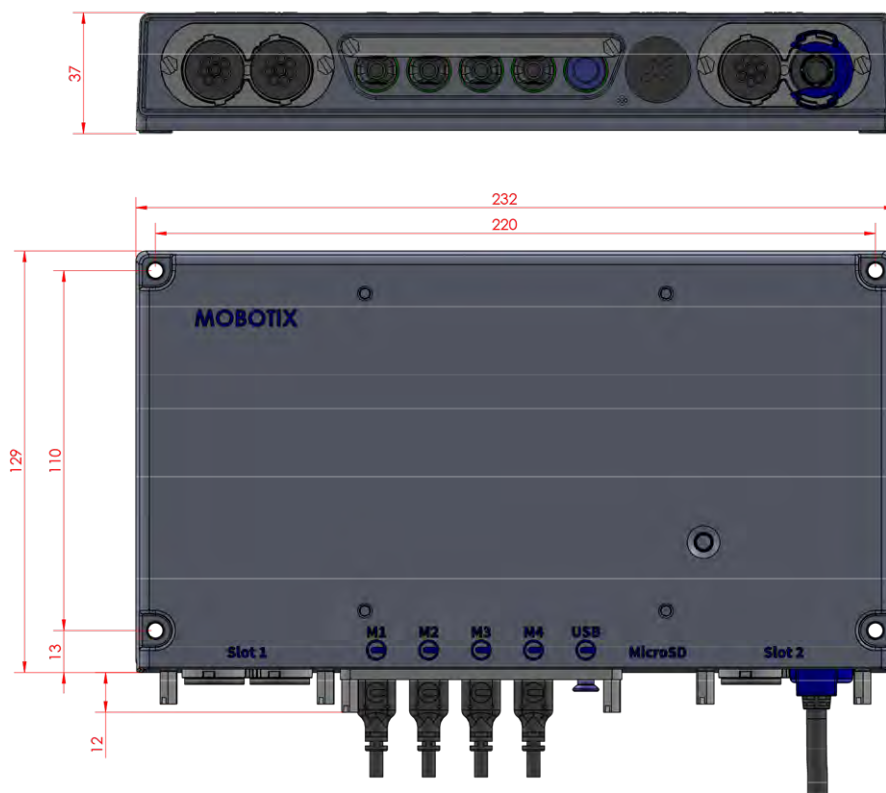

Fig. 5: S74: All measurements in mm

PTMount – Dimensions

Note

You can download the drilling template from the MOBOTIX website: www.mobotix.com > Support > Download Center > Marketing & Documentation > Drilling Templates.

Attention!

Always print or copy at 100% of the original size!

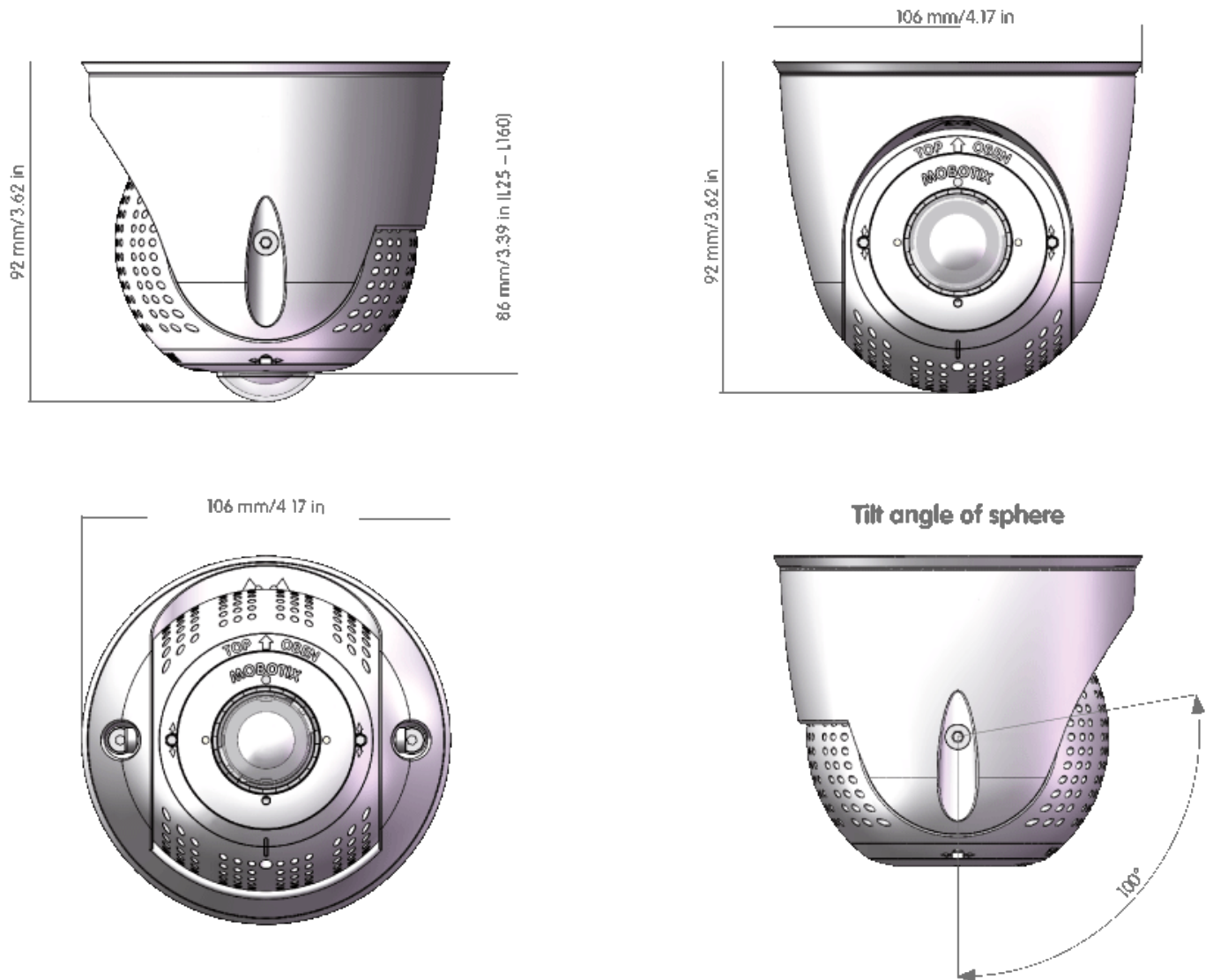

Fig. 6: PTMount

PTMount-Thermal – Dimensions

Note

You can download the drilling template from the MOBOTIX website: www.mobotix.com > **Support** > **Download Center** > **Marketing & Documentation** > **Drilling Templates**.

Attention!

Always print or copy at 100% of the original size!

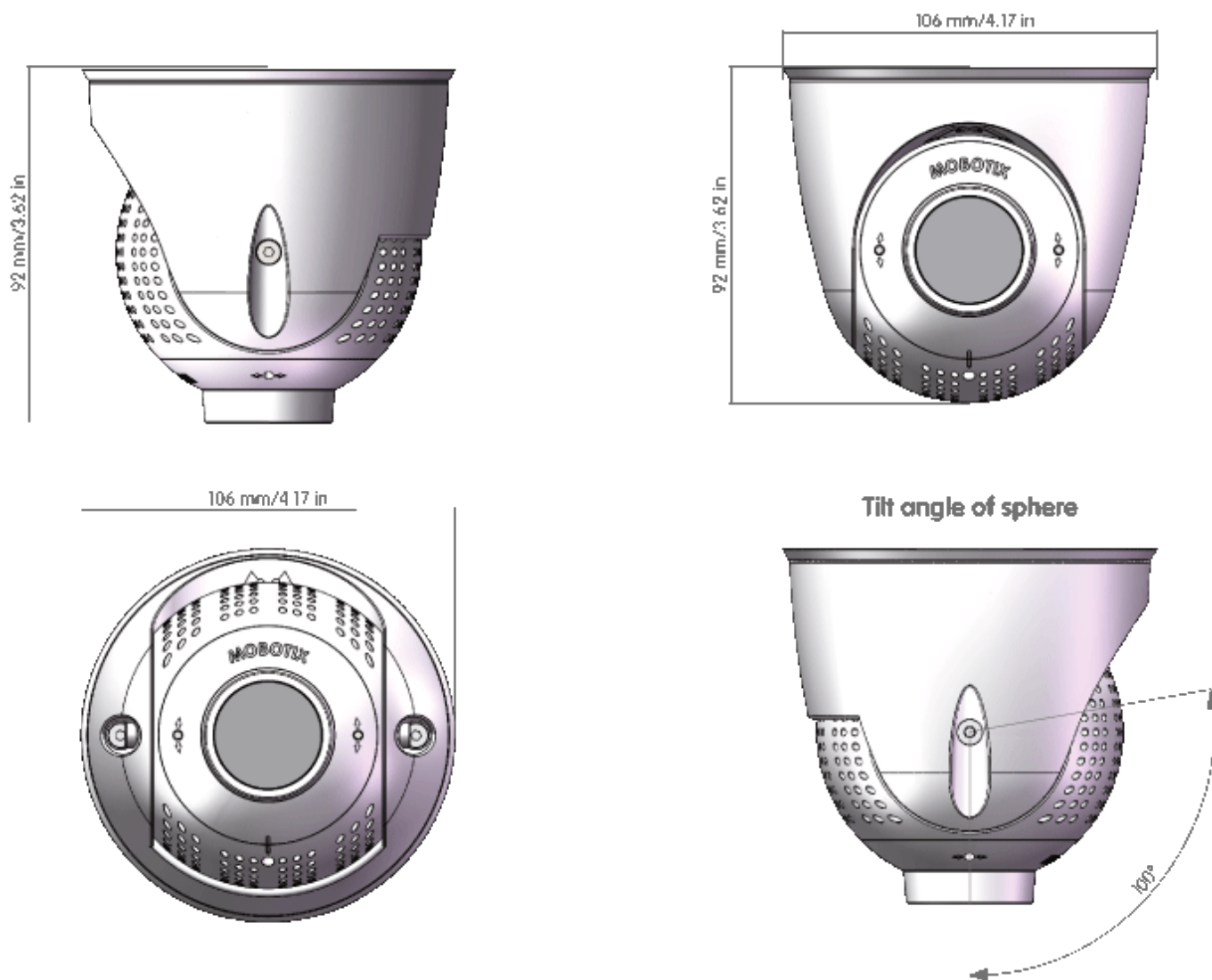

Fig. 7: PTMount-Thermal

Technical Specifications

Hardware

Image sensor (color or B&W sensor)	up to 4K UHD 3840x2160, 16:9, 1/1,8"
Light sensitivity	- Color sensor (day): 0,1 lx @ 1/60s; 0,005 lx @ 1s - BW sensor (night): 0,02 lx @ 1/60s; 0,001 lx @ 1s
Exposure control	Manual and automatic mode 1 s to 1/16,000 s
Video codecs	H.264, H.265 with Triple Streaming MxPEG+ MJPEG
IK protection class	IK10 (housing)
IP protection class	IP66
Ambient temperature (range, including housing)	-40 to 65 °C/-40 to 149 °F/95 % rel. humidity (non-condensing)
Internal DVR, out of the box	MicroSD card (8 GB), MxPEG+ recording only

Technical Specifications

I/Os	1 input/1 output via IO Interface Board (Mx-F-S7A-INT01)
Microphone/Speaker	Functional audio module, max. 4.5 Watt (see Supported Functional Modules, p. 27) Microphone Sensitivity: -35 +-4dB (0dB = 1V/pa, 1kHz) Speaker: 0,9W at 80hm
Microphone/Speaker	Functional audio module, max. 4.5 Watt (see Supported Functional Modules, p. 27)
Passive infra-red sensor (PIR)	Available with functional module, max. 4.5 Watt (see Supported Functional Modules, p. 27)
Infra-red illumination	Three functional modules for wide-angle, standard, and tele lenses
Range of infra-red illumination	Up to 30 m/100 ft (may be more depending on scene)
Max. power consumption	25 Watt
PoE standard	PoE Plus (802.3at-2009)/Class 4
Interfaces	4 sensor / functional modules Ethernet 1000BaseT USB-C
Mounting Options	Wall-mountable
Dimensions (height x width x depth)	36 x 232 x 110 mm
Weight without sensor modules	1.130g
Housing	Aluminum, PBT-30GF
Detailed technical documentation	www.mobotix.com > Support > Download Center > Marketing & Documentation
MTBF	80,000 hours
Certificates	EN 55032:2012AC:2013 Class A, EN 55035:2017, EN 50121-4:2016, EN 61000-6-1:2007, EN 61000-6-2:2015, EN 61000-6-3:2007A1:2011+AC:2012, EN 61000-6-4:2007A1:2011, EN50581:2012, EN 62368-1:2014+AC:2015A11:2017+AC:2017, 47 CFR Part 15b Class A, AS/NZS CISPR 32:2015 Class A
Protocols	DHCP (client and server), DNS, ICMP, IGMP v3, IPv4, IPv6,

HTTP, HTTPS, FTP, FTPS, NFS, NTP (client and server), RTP, RTCP, RTSP, SIP (client and server), SMB/CIFS, SNMP, SMTP, SSL/TLS 1.3, UDP, VLAN, VPN, Zeroconf/mDNS

Manufacturer warranty 3 years

Image Formats, Frame Rates, Image Storage

Available video codecs MxPEG+/MJPEG/H.264/H.265

Image resolutions VGA 640x360, XGA 1024x576, HD 1280x720, FullHD 1920x1080, QHD 2560x1440, 4K UHD 3840x2160

H.264 multi streaming Triple Streaming

Multicast stream via RTSP Yes

Max. image resolution (dual image of both sensors) 4K UHD 3840x2160 (8MP)

Max. frame rate MxPEG: 20@4K, H.264: 30@4K, H.265: 30@4K

General Features

WDR Up to 120 dB

Software features

- H.264, H.265 Multistreaming
- Multicast stream via RTSP
- Digital pan, tilt, zoom / VPTZ(up to 8x zoom)
- Genetec protocol integration
- Custom exposure zones
- Snapshot recording (pre/post-alarm images)
- Continuous recording
- Event recording
- Time controlled flexible event logic
- Weekly schedules for recordings and actions
- Event video and image transfer via FTP and email
- Playback and QuadView via web browser
- Animated logos on the image
- Master/Slave functionality
- Privacy zone scheduling
- Remote alarm notification (network message)
- Programming interface (HTTP-API)
- MOBOTIX MessageSystem

Technical Specifications

ONVIF compatibility	Profile S, T
Master/Slave functionality	Yes
Remote alarm notification	email, network message (HTTP/HTTPS), SNMP, MxMessageSystem
DVR/storage management (MxPEG+ only)	Within the camera via microSD card, on external USB and NAS devices, different streams for live image and recording, MxFFS with buffered archive, pre- and post-alarm images, storage monitoring with error reporting
Camera and data security	User and group management , SSL connections, IP-based access control, IEEE 802.1X, intrusion detection, digital image signature

Video Analysis

Video motion detection	Yes
MxActivitySensor	Version 1.0, 2.1 and object-based MxAnalytics AI
ONVIF compatibility	Profile S, T*
MxAnalytics	Heatmap, people counting & object-based counting
MOBOTIX App support	Yes

Video Management Software

MxManagementCenter	Yes (MxMC 2.2 and higher) www.mobotix.com > Support > Download Center > Software Downloads
MxBell	Yes www.mobotix.com > Support > Download Center > Software Downloads

Dimensions of Sensor Modules

Dimensions (height x width)	58 x 42,5 (50 mm)
-----------------------------	-------------------

Weight of Sensor Modules

Standard Sensor Modules	max. 150g
Functional Modules	max. 150g
Thermal Sensor Module	380g
PTMount Thermal	890g

Features Thermal Sensors

Sensitivity thermal image sensor	Typ. 50 mK, IR range 7.5 to 13.5 μm ; Temperature Measurement Range: -40 to 550 $^{\circ}\text{C}$ / -40 to 1022 $^{\circ}\text{F}$
Image sensor: Thermal image sensor	Uncooled microbolometer, CIF: 336 x 256 pixels / VGA: 640 x 480
Max. image size MX sensor module	Can be scaled up to 3072 x 2048 (6MP), automatically scaled to size of MX sensor module
Max. frame rate Thermal image sensor	9 fps (when displaying an MX sensor module and a thermal sensor module, the overall frame rate of the camera is reduced to 9 fps)
Software (included)	Video management software MxManagementCenter

Supported Sensor Modules

Sensor Module	Order Code
Sensor module with standard 45° lens	Mx-O-M7SA-8DN100
	Mx-O-M7SA-8D100
	Mx-O-M7SA-8N100
	Mx-O-M7SA-4DN100
Sensor module with tele lens 30°	Mx-O-M7SA-8DN150
	Mx-O-M7SA-8D150
	Mx-O-M7SA-8N150
	Mx-O-M7SA-4DN150
Sensor module with tele lens 15°	Mx-O-M7SA-8DN280
	Mx-O-M7SA-8D280
	Mx-O-M7SA-8N280
	Mx-O-M7SA-4DN280
Sensor module with wide angle lens 60°	Mx-O-M7SA-8DN080
	Mx-O-M7SA-8D080
	Mx-O-M7SA-8N080
	Mx-O-M7SA-4DN080
Sensor module with super wide angle lens 95°	Mx-O-M7SA-8DN050
	Mx-O-M7SA-8D050
	Mx-O-M7SA-8N050
	Mx-O-M7SA-4DN050

Technical Specifications

Sensor Module	Order Code
Sensor module with ultra wide angle lens 120° 4K	Mx-O-M7SA-8DN040
	Mx-O-M7SA-8D040
	Mx-O-M7SA-8N040
	Mx-O-M7SA-4DN040
Sensor Module	Order Code
Sensor module with standard 45° lens	Mx-O-M7SA-8DN100
	Mx-O-M7SA-8D100
	Mx-O-M7SA-8N100
	Mx-O-M7SA-4DN100

Supported Thermal Sensor Modules

Sensor module	Order code
CIF Thermal 45° x 35°	Mx-O-M7SA-336TS100
CIF Thermal 25° x 19°	Mx-O-M7SA-336TS150
CIF Thermal 17° x 13°	Mx-O-M7SA-336TS280
CIF Thermal Radiometry 45° x 35°	Mx-O-M7SA-336RS100
CIF Thermal Radiometry 25° x 19°,	Mx-O-M7SA-336RS150
CIF Thermal Radiometry 17° x 13°	Mx-O-M7SA-336RS280
VGA Thermal 90° x 69°	Mx-O-M7SA-640TS050
VGA Thermal 69° x 56°	Mx-O-M7SA-640TS080
VGA Thermal 45° x 37°	Mx-O-M7SA-640TS100
VGA Thermal 30° x 26°	Mx-O-M7TA-640TS150
VGA Thermal Radiometry 90° x 69°	Mx-O-M7TA-640RS050
VGA Thermal Radiometry 69° x 56°	Mx-O-M7TA-640RS080
VGA Thermal Radiometry 45° x 37°	Mx-O-M7SA-640RS100
VGA Thermal Radiometry 30° x 26°	Mx-O-M7SA-640RS150

The **Thermal Radiometry** variants automatically alarm when the temperature exceeds or falls below defined limits. This is crucial for the detection of fire or heat sources. Up to 20 different temperature events can be configured simultaneously in so-called TR windows or over the complete sensor image over a temperature range of -40 to 550 °C/-40 to 1022 °F.

The **Thermal** variants only measure in the center of the image (2x2 pixel spotmeter).

Supported Functional Modules

Functional audio module	via IO Interface Board
Functional MultiSense module	Mx-F-MSA with PIR sensor, temperature sensor, illumination sensor
Functional IR Light module	Mx-F-IRA-W for Wide-Angle Lens (95°) Mx-F-IRA-S for Standard Lens (45° – 60°) Mx-F-IRA-T for Tele Lens (15° – 30°)

Mounting

Attention!

Make sure to copy the IP address (1) on the back of the camera housing or on the camera packaging! You will need this address to configure the camera in the browser later on (see [Camera Software in the Browser, p. 67](#)).

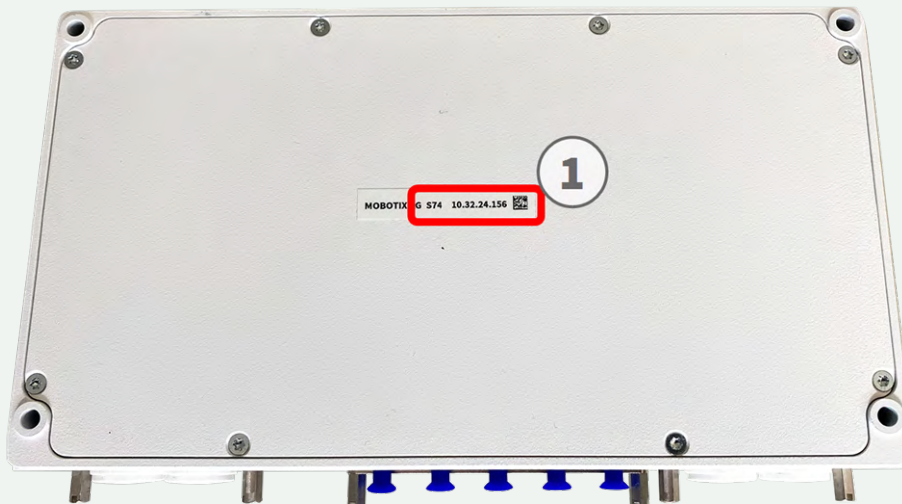

Fig. 8: IP address on the back of the camera housing

The MOBOTIXS74 has been designed for wall mounting. Using the pole mount accessory, you can also install the camera on a pole (see [Mounting Options: Wall or Pole, p. 1](#)).

Note

You can download the drilling template from the MOBOTIX website: www.mobotix.com > [Support](#) > [Download Center](#) > [Marketing & Documentation](#) > [Drilling Templates](#).

Attention!

Always print or copy at 100% of the original size!

Before Mounting the Camera

Before mounting the MOBOTIX S74, the following questions should be answered:

- Where and how will the camera be mounted?
- Where and how will the sensor modules be mounted?
- How is the mounting surface level?
- Which other mounting options are available?
- Which accessories might be needed?
- How is the camera connected to the network and how is the power supplied?
- How are the connections furnished from the building?
- What cabling considerations are necessary?

Caution!

Installation only on flat surface!

Only use genuine MOBOTIX patch cables to guarantee the weatherproofness!

If you have questions, please ask your MOBOTIX partner directly or contact the MOBOTIX support under www.mobotix.com > [Support](#) > [Help Desk](#).

Protective Measures

Warning!

When laying cables indoors and outdoors, the current regulations for cable laying, lightning and fire protection must always be observed.

MOBOTIX cameras are protected against the effects of minor over voltages by a number of measures. However, these measures cannot prevent larger surge voltages from causing damage to the camera. When installing the cameras outdoors, special attention should therefore be paid to lightning protection and the associated dangers for the building and network infrastructure.

In general, you should only have MOBOTIX cameras installed by certified specialist companies that are familiar with the installation and safe operation of network devices and the underlying regulations for lightning and fire protection as well as the current technology for preventing damage from surge voltages.

Cable laying

- **Data cable:** Only double-shielded CAT5 cable or better (S/STP) may be used as data cable for the Ethernet interface. outdoor use: For outdoor use, special requirements apply for the cables to be used and the lightning protection.
- **Cable length:** The individual cable sections must not exceed the maximum permissible lengths in order to ensure perfect data transmission.
- **Avoidance of induction:** Data cables may only be laid parallel to power or high-voltage lines if the prescribed minimum distances are observed.
- Only original MOBOTIX cables should be used to connect the sensor modules, patch cables and USB cables in order to guarantee weather resistance according to IP66. The plugs supplied must be used if additional cables are required (MxBus, audio).

Fire Protection

When laying cables for the power supply, the relevant country-specific regulations (e.g. VDE in Germany) and the fire protection regulations valid at the installation site must be observed.

Lightning and surge protection

The MX-Overvoltage-Protection-Box should always be used to prevent damage to MOBOTIX cameras due to over voltage. This weatherproof network connector offers reliable protection against over voltages of up to 4 kV.

Further information on how to avoid damage caused by lightning and over voltage is available from manufacturers of lightning and over voltage protection devices.

Sealing sensor modules and connectors

Mount the S74 sensor modules so as to avoid the accumulation or of water or other liquid around the cable connection on the back of the housing or a build-up of condensation inside the sensor module and its subsequent failure.

Unused connectors on the housing of the S74 must always be sealed using the plugs installed as standard on delivery as well as the corresponding retainers.

Installing Sensor Modules

Warning!

Make sure the power supply to the camera is disconnected before installing or replacing sensor modules.

Warning!

When installing the sensor modules, make sure that the sensor module cables are not damaged or bent sharply!

Prepare the Sensor Modules

Remove the plastic nut (1) from the sensor modules, remove the bayonet catch (2) by rotating it counter-clockwise, then remove the blue rubber plug (3).

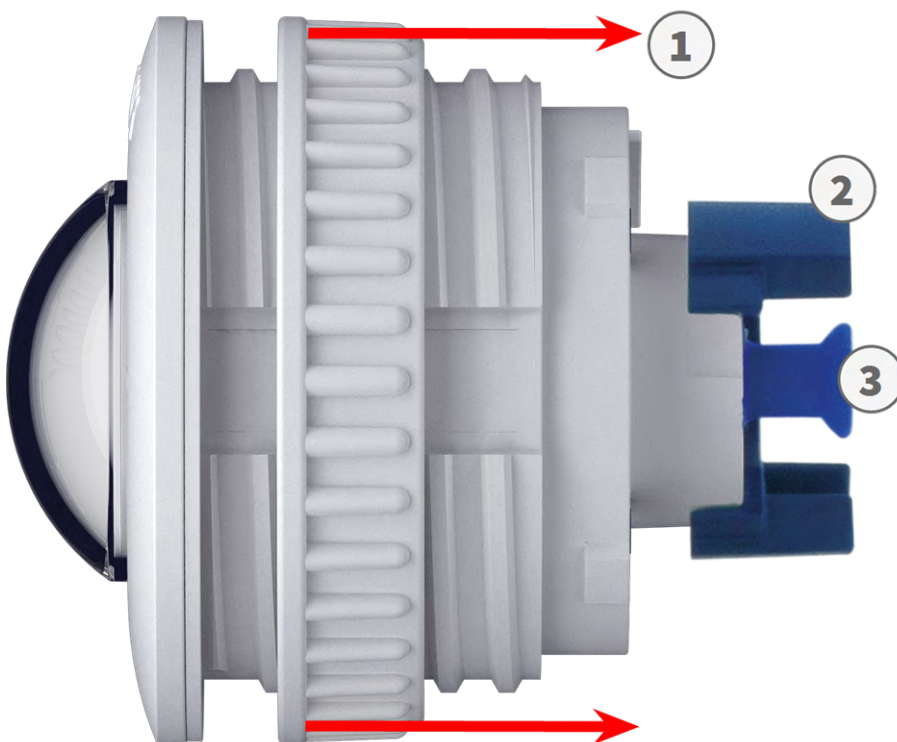

Fig. 9: Prepare sensor module for mounting

Proceed by Installing the Sensor Modules

- [Without Mounts, p. 33](#)
- [With PTMount, p. 35](#)
- [With PTMount-Thermal, p. 41](#)
- [With DualMount](#)

Without Mounts

Procedure

1. **Mount the sensor module:** Insert sensor module into hole (43 mm) (1) and tighten the plastic nut (2) to keep the sensor module safely in place

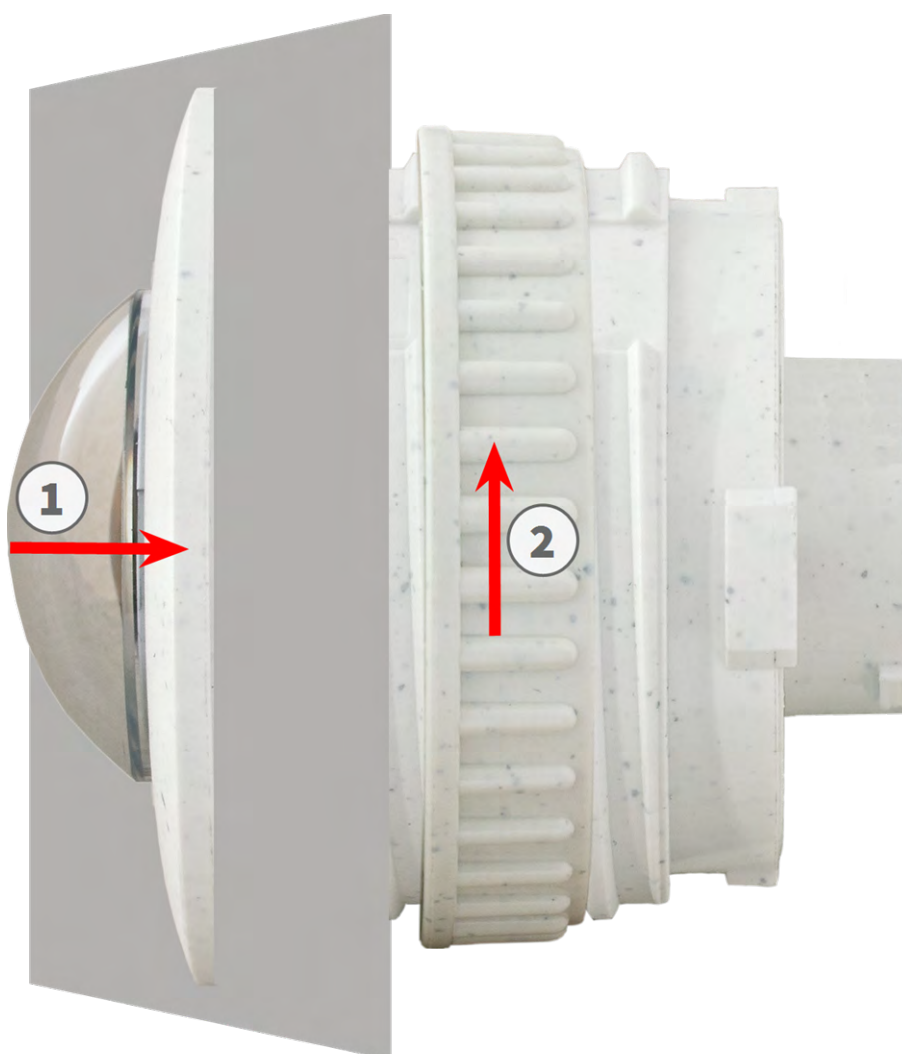

Fig. 10: Mount the sensor module

Mounting

Installing Sensor Modules

2. **Connect the sensor module cable:**

Push the plug of each sensor module cable **firmly** into the connector at the back of the module until the connector is fully inserted into its seat until it doesn't go in any further.

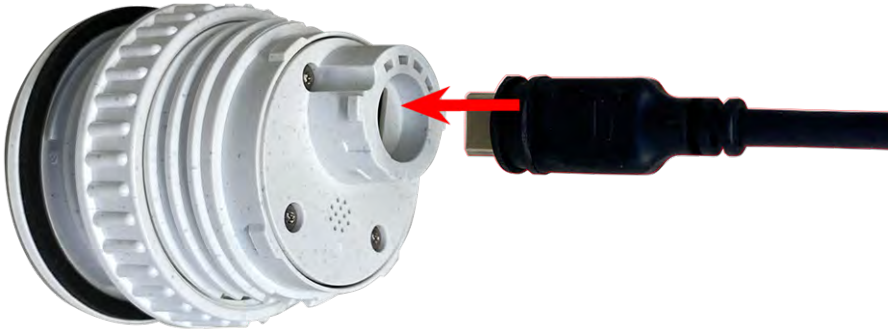

Fig. 11: Connect the sensor module cable

3. **Lock sensor module cable:** Apply the blue bayonet catch onto the connector of the sensor module as shown and turn it clockwise until it gently snaps shut.

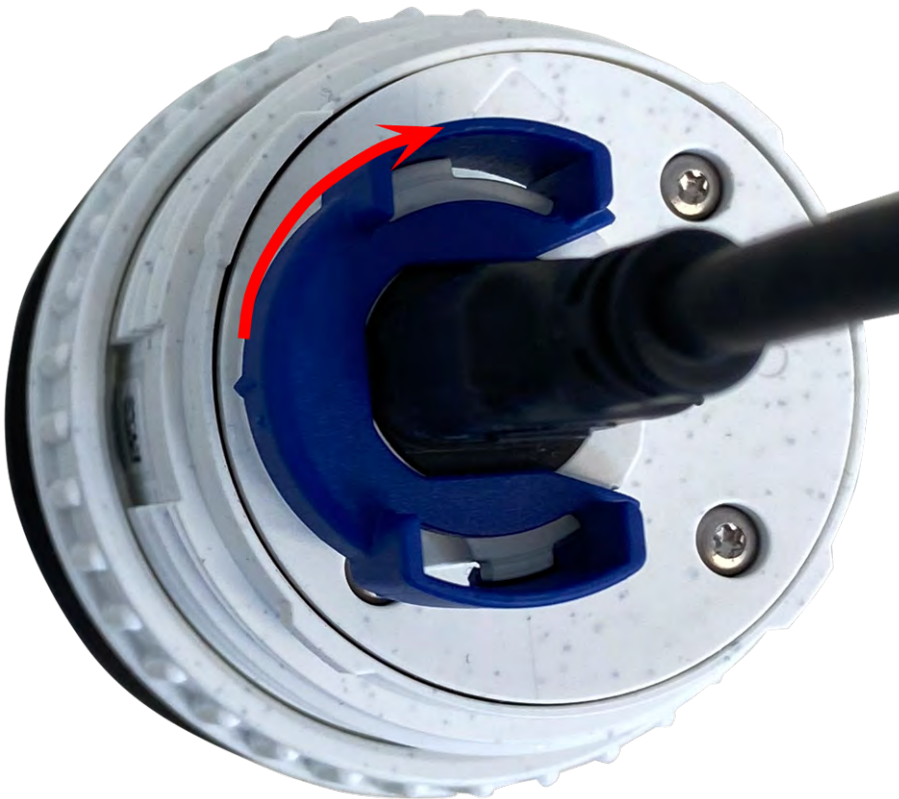

Fig. 12: Lock sensor module cable

4. Repeat steps 1 to 4 to add additional sensor modules, respectively.

With PTMount

Prepare the PTMount

1. Using the 2.5 mm Allen wrench, remove the two screws that hold the foot onto the swivel ring.



2. Remove swivel ring and base plate.



3. Make sure that there is enough space for installing the PTMount and that you can access it from the rear later on. The surface should be even and smooth so that the sealing lies flat on the surface



Fig. 13: Sealing (dia. 106 mm)

4. Drill the holes for the base plate using the drilling template and insert the screw anchors
[PTMount: Scope of Delivery, p. 16.](#)



5. In the center of the drilling template, drill another hole into the wall or faceplate for the sensor module cable. The hole should have a diameter between 15 and 35 mm.



Fig. 14: Holes ready for mounting

Installing the PTMount and the Sensor Module

1. Hold the sealing, the swivel ring and the base plate as shown in the figure.



2. Attach the base plate using the supplied wood screws and washers.



3. When tightening the screws, make sure that you can still rotate the swivel ring by hand.



4. • Guide the sensor cable through the sealing, the swivel ring, the base plate and through the mounting surface to the camera.



5. Guide the sensor cable from the back into the foot and the sphere.



6. Use the two screws to affix the foot and sphere assembly to the swivel ring and make sure that the foot can still be rotated.



Mounting

Installing Sensor Modules

7. Loosen the two fastening screws of the insert (1), then rotate the insert so that the small bar opposite of the **TOP/OBEN** label points to the hole of the grub screw (2).

Secure the insert against rotating by tightening the two fastening screws using the 2.5 mm Allen wrench.

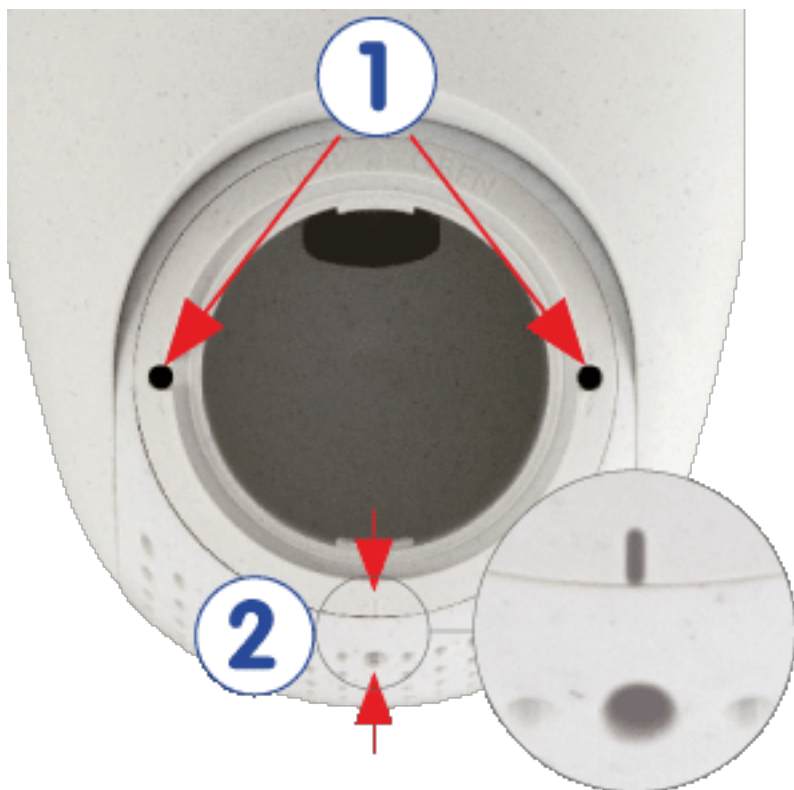

8. Attach the sensor module cable to the sensor module (turn blue bayonet catch to the left and remove, pull out the plug, connect the sensor cable, apply bayonet catch and lock by turning to the right).



9. Push the sensor module into the PTMount so that the **MOBOTIX** lettering is turned 90 degrees to the left vs. the **TOP/OBEN** lettering.



10. Using the module wrench (red or black), lock the sensor module by turning it 90 degrees to the right.



Mounting

Installing Sensor Modules

11. Secure the sensor module by tightening the grub screw using the 2.5 mm Allen wrench. The grub screw locks the sensor module within the insert and prevents inadvertent unlocking of the sensor module.



12. Adjust the sensor module temporarily by pointing it into the desired viewing direction.



13. Make sure that the **TOP/OBEN** label on the insert is pointing upwards. If this is not the case, loosen the two fastening screws using the 2.5 mm Allen wrench and rotate the insert.



With PTMount-Thermal

Prepare the PTMount-Thermal

1. Using the 2.5 mm Allen wrench, remove the two screws that hold the foot onto the swivel ring.



2. Remove swivel ring and base plate.



Mounting

Installing Sensor Modules

3. Make sure that there is enough space for installing the PTMount-Thermal and that you can access it from the rear later on. The surface should be even and smooth so that the sealing lies flat on the surface



Fig. 15: Sealing (dia. 106 mm)

4. Drill the holes for the base plate using the drilling template and insert the screw anchors [PTMount-Thermal: Scope of Delivery, p. 17.](#)



5. In the center of the drilling template, drill another hole into the wall or faceplate for the sensor module cable. The hole should have a diameter between 15 and 35 mm.



Fig. 16: Holes ready for mounting

Installing the PTMount-Thermal and the Sensor Module

1. Hold the sealing, the swivel ring and the base plate as shown in the figure.



2. Attach the base plate using the supplied wood screws and washers.



- When tightening the screws, make sure that you can still rotate the swivel ring by hand.



- Carefully guide the sensor cable through the sealing, the swivel ring and the base plate.



- Use the two screws to affix the foot and sphere assembly to the swivel ring and make sure that the foot can still be rotated.



Mounting

Installing Sensor Modules

- Adjust the sensor module temporarily by pointing it into the desired viewing direction.



- Make sure that the **MOBOTIX** label on the insert is pointing upwards. If this is not the case, loosen the two fastening screws with the 2 mm Allen wrench and rotate the insert. Lightly tighten the two fastening screws.



Installing the RJ45 Interface Board

An RJ45 interface board is required to connect the camera to the network and to supply power via PoE. The RJ45 Interface Board is not part of the scope of delivery (see [Delivered Parts and Dimensions](#), p. 13) and must be ordered in addition to the camera.



Fig. 17: RJ45 interface board

Caution!

The RJ45 Interface Board may only be installed in slot 2 of the camera!

Procedure

1. **Remove cover from slot 2 of the camera:** Use a screwdriver to loosen both bolt screws (1) and then pull out the plastic cover.

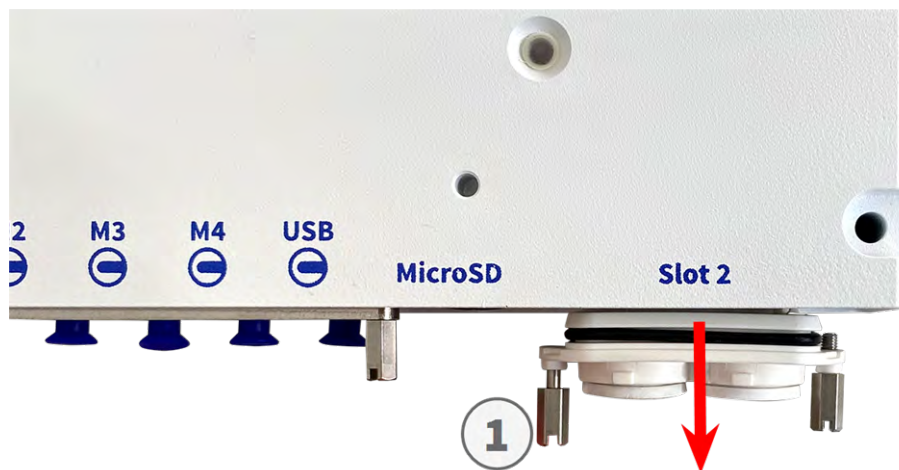

Fig. 18: Remove cover from interface board slot

Mounting

Mounting the Camera

2. **Connect the RJ45 Interface Board:** Position the interface board on the guide rails in the slide-in slot and push it in with slight pressure until it clicks into the socket. Then fix the board with the screw bolts (1).

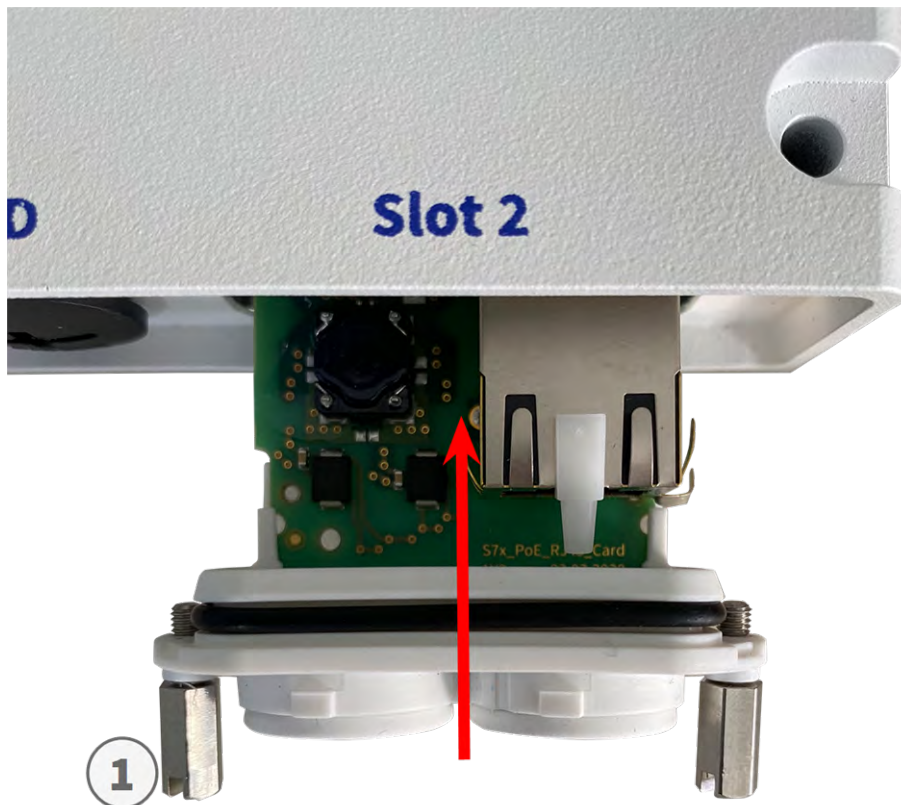

Fig. 19: Connecting the RJ45 Interface Board

Caution!

Do not connect the network cable at this stage! Since the camera must not run without sensor modules, the network connection will be established only **after** mounting the camera and connecting the sensor modules.

Mounting the Camera

You can mount the S74 to any even surface.

Before mounting the MOBOTIX S74 and sensor modules, determine the ideal positions and make sure that the field of view is not obstructed in any way. Once the modules have been mounted, you can fine-tune the image. If the monitored area changes or the camera has to be installed in a different location, you can exchange the sensor modules.

Before mounting the camera, make sure that a network connection with power supply according to the PoE Plus (802.3at-2009) standard is available at the mounting position (see [Connecting the Camera to the Network](#), p. 50).

Note

You can download the drilling template from the MOBOTIX website: www.mobotix.com > **Support** > **Download Center** > **Marketing & Documentation** > **Drilling Templates**.

Attention!

Always print or copy at 100% of the original size!

Note

Do not use the dowels if the installation surface is wood. Only use the screws to fasten the mounting plate directly on the surface. In order to facilitate screwing in wood, the positions should first be pre-drilled using a 2 mm drill bit, for example (drilling depth just slightly less than screw length).

Procedure

1. **Drill the holes:** Mark the holes for drilling using the drilling template (see [Drilling Template as PDF](#)). When drilling, use a suitable 8 mm drill bit and drill holes with at least 60 mm/1.2" depth. Fully push the dowels M.5 into the holes you drilled.
2. **Install the mounting plate:** Place the Camera over the drilled holes (1) and use the four screws M.4 with one washer M.6 each and the Phillips screwdriver to mount the plate to the wall.

Caution!

Installation only on flat surface.



Fig. 20: Mounting plate installed on wall

Connecting Sensor Modules

Up to 4 sensor modules can be connected to the camera. Additionally a USB-C interface is available

Mounting

Connecting Sensor Modules



Fig. 21: Module Connector Ports

Procedure

1. Use a screwdriver to loosen both bolt screws (1) and then pull of the module latch.

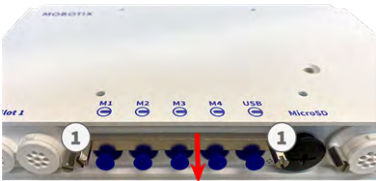

2. Remove the blue rubber plug (1) from the module connector.

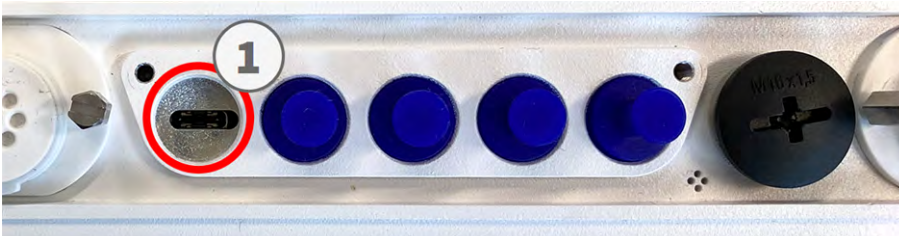

3. Plug the module cable into the module connector.

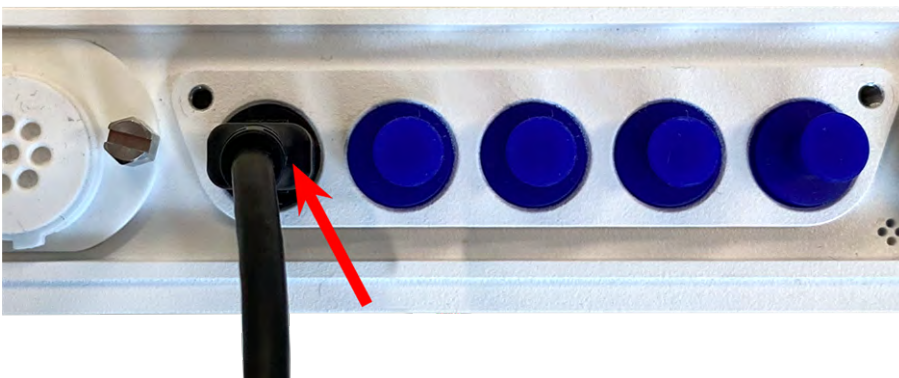

4. Fasten the module latch by fastening the two screws shown below.



5. Repeat steps 1 to 5 to connect additional modules

Sensor Module Combinations

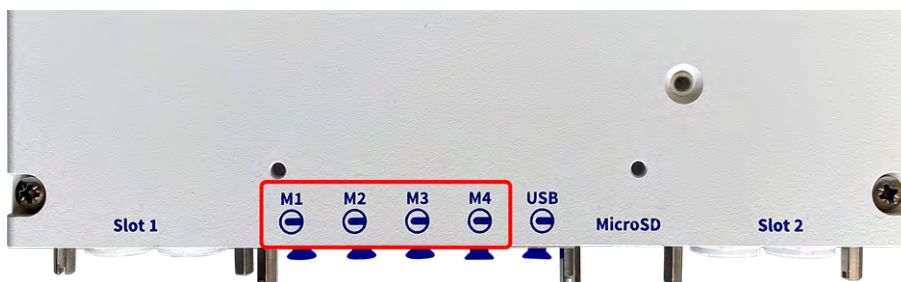

Fig. 22: Module connectors of the S74

You can use the following combinations of sensor modules, thermal, and functional modules on the MOBOTIX S74:

Module	Module Connectors				Comments
	M1	M2	M3	M4	
Optical Sensor Modules					
Mx-O-M7SA-8DN050	yes	yes	no	no	4K IR Cut 90°
Mx-O-M7SA-8D050	yes	yes	no	no	4K Day 90°
Mx-O-M7SA-8N050	yes	yes	no	no	4K Night 90°
Mx-O-M7SA-4DN050	yes	yes	no	no	ULL IR Cut 90°

Thermal Sensor Modules

Mounting

Connecting the Camera to the Network

Module	Module Connectors				Comments
	M1	M2	M3	M4	
Mx-O-M7SA-640R050	no	no	yes	no	Thermal VGA Radiometry 90°
Mx-O-M7SA-640T050	no	no	yes	no	Thermal VGA 90°
Mx-O-M7SA-336R100	no	no	yes	no	Thermal CIF Radiometry 45°
Mx-O-M7SA-336T100	no	no	yes	no	Thermal CIF Radiometry 45°
IR Light Modules					
Mx-F-IRA-W	yes	yes	yes	yes	IR light 850 nm for Wide-Angle Lens (95°)
Mx-F-IRA-S	yes	yes	yes	yes	IR light 850 nm for Standard Lens (45° – 60°)
Mx-F-IRA-T	yes	yes	yes	yes	IR light 850 nm for Tele Lens (15° – 30°)
Other Functional Modules					
Mx-F-MSA	yes	yes	yes	yes	MultiSense module
Mx-F-Audio	no	no	no	no	Speaker/Microphone; not applicable on S74 use the Audio IO Interface Board instead

Connecting the Camera to the Network

All connections of the camera (network, power supply, inputs/outputs) are established via an RJ45-interface board (see [Installing the RJ45 Interface Board, p. 45](#)). A PoE switch provides the camera's power supply.

Important to know:

- The PoE switch must provide Class 4 according to PoE Plus (802.3at-2009) as well as the 100/1000 Mbps Ethernet interface of the camera.
- It is highly recommended to use an uninterruptible power supply (UPS) for the switch.
- The maximum length of the network cable for remotely supplying power is 100 m (300 ft).



Fig. 23: Power supply using PoE switch according to PoE Plus (802.3at-2009)

Connecting the RJ45 Connector Box

1. Remove the white rubber plug from the RJ45 network connector.
2. Plug the network cable of the camera into the network connector.
3. Press the plug in firmly until the blue sealing ring clicks into place.



Fig. 24: Press the plug in firmly until the blue sealing ring clicks into place

Operating the Camera

Getting Started

You can use the S74 with any current browser – or with MxManagementCenter. You can download MxManagementCenter free-of-charge from www.mobotix.com > **Support > Download Center > Software Downloads**.

Procedure

1. **Connect the camera to the network.** The network cable will also provide power to the camera (see [Connecting the Camera to the Network](#), p. 50).

- 2. Establish a connection to the camera and adjust the network settings if required:** By factory default, MOBOTIX cameras are booting as DHCP client with an additional fixed IP address in the 10.x.x.x range (e.g., 10.16.0.128). Local computer networks usually have IP addresses in the 172 or 192 ranges. Depending on whether a DHCP server is present on the local network or if the network has been set up to use fixed IP addresses, there are several possibilities for establishing a connection to the camera and to change its [Network Settings](#), p. 57:
 - **Network with dynamic IP addresses**

Using a browser: If you know the IP address that the DHCP server assigned to the camera, simply enter that address in the browser address bar to directly connect to the camera

Using MxManagementCenter: With MxManagementCenter, you can show and integrate the camera without having to know its current IP address.
 - **Network with static IP addresses**

In order to access the camera, it must have an IP address within the range of the local network. To set the camera's network parameters, you can use one of these methods:

Manually using a web browser: You may have to adjust the network settings of your computer.
 - **Automatically using MxManagementCenter:** The camera is displayed in MxManagementCenter although the IP address is not part of the local network, allowing you to reconfigure its settings.
- 3. Configure camera:** You can use the user interface of the camera in a browser or in MxManagementCenter.

Boot Options of the Camera

By default, the camera starts as DHCP client and automatically tries to get an IP address from a DHCP server. To start the camera in a mode different from the default mode, you can activate the boot menu of the camera.

Note

Pressing the key of the camera will let the camera announce the current IP address of the camera on the speaker (if a speaker is attached to the camera).

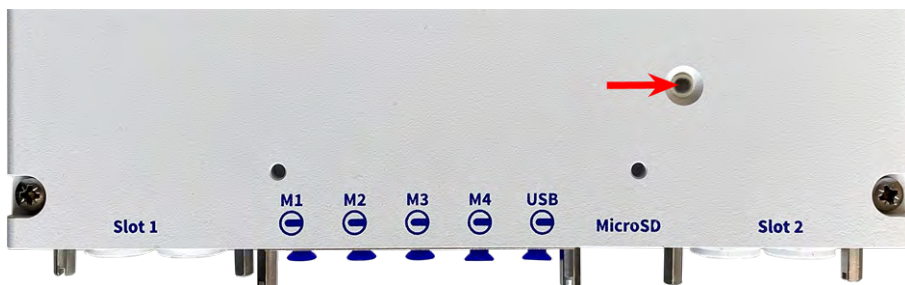

Fig. 25: Camera LED on top of the camera body

Procedure

Caution!

When opening the camera, do not insert any objects into the housing. This could damage the camera!

1. Prepare the camera:

- Disconnect the camera's power supply.
- Remove the black cover screw (1) with a screwdriver.

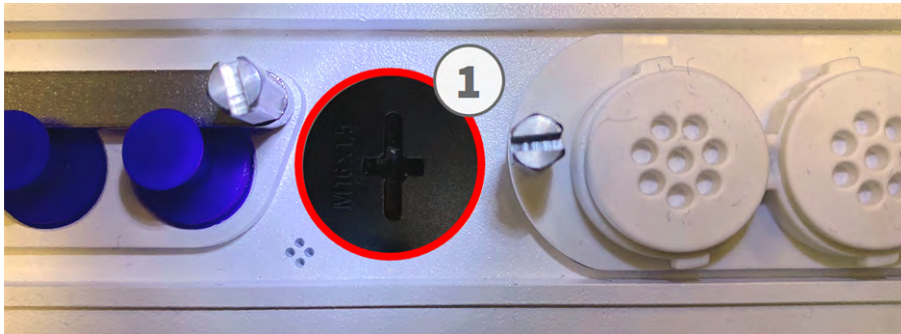

- Take a suitable tool for operating the boot menu (e.g. the tweezers [M.3](#)).
- Reconnect the power supply of the camera.

2. Activate the boot menu: The red LED on top of the camera body lights up 5 to 10 seconds after establishing the power supply and will stay on for 10 seconds.

- Press the key by inserting the tool into the hole (2). The camera enters the boot menu, ready for selecting one of the boot options. The LED will flash once. The flash signal will be repeated every second.



Note

The number of flashes corresponds to the current boot option.

Operating the Camera

Boot Options of the Camera

- **Switch the boot option:** Briefly press the key (< 1 sec). After the last boot option, the camera returns to the first boot option (LED flashes once).

LED flashes	Boot Option	Meaning	Audio Confirmation*
1x	•/•	This option is not supported on this camera model.	•/•
2x	Factory Defaults	Starts the camera with factory defaults (factory default IP address, users and passwords will not be reset).	Boing
3x	Automatic IP Address	Starts the camera as DHCP client and tries to obtain an IP address from a DHCP server. If a DHCP server cannot be found or no IP address can be obtained, the camera starts with its factory default address.	Boing-Boing
4x	Recovery System	Starts the camera with the recovery system, e.g., in order to recover from a failed update of the camera software.	Alarm Sound

*Only on cameras with audio option and installed speaker.

3. **Select a boot option:** Press the key longer (> 2 sec). The camera confirms the selection by flashing the LED rapidly for 3 seconds. After 20 sec, the camera will play a sound according to the table above.
4. Insert the Allen screws and the plastic washer using the Allen wrench 2.5 mm M.7 and take care not to over-tighten the screw.

Note

If you do not select a boot option, the camera will resume its normal boot process after a certain time.

Attention

Starting the Camera With Factory Defaults or an Automatic IP Address (DHCP)

The configurations loaded when using the boot options 2 and 3 will not be automatically saved to the camera's flash memory. Upon starting the camera the next time, the camera will use the last configuration it stored. You can store the configuration in the camera's flash memory using the **Admin Menu > Store** command. Note that you can restore specific parts of the camera configuration afterwards by using "Restore" to re-apply the settings still stored in the camera.

As opposed to resetting the camera using **Admin Menu > Reset configuration to factory defaults**, the user information will not be reset if the camera is booted using the factory defaults.

When starting the camera with DHCP support (option 2), make sure that the network has a properly functioning DHCP server. If this is not the case, the camera cannot obtain a valid IP address and will fall back to its last IP address.

You should also make sure that the cameras always get the same IP addresses by mapping the MAC addresses of the cameras to the desired IP addresses.

Network Settings

Once the camera has been connected to the network, you need to set up the MOBOTIX camera's network interface accordingly. This step involves setting up and checking the network parameters of the camera. If your network has an active DHCP server or if it is already running on a 10.x.x.x network with a 255.0.0.0 network mask) you do not need to change the camera's network parameters. You can directly access the camera. If neither your network nor your computer use an IP address in the 10.x.x.x network (e.g. a 192.168.x.x or 172.x.x.x network), you should follow one of the following methods for changing the camera's network parameters:

- Manual setup
- Automatic setup using MxManagementCenter

Note

For the following examples, we will use a camera with the factory IP address 10.16.0.99. Replace this IP address with the IP address of your camera. You will find this address on a small sticker on the camera. Make sure that the IP addresses used in the following examples are not used by any other devices on your network.

Windows 8.1/10

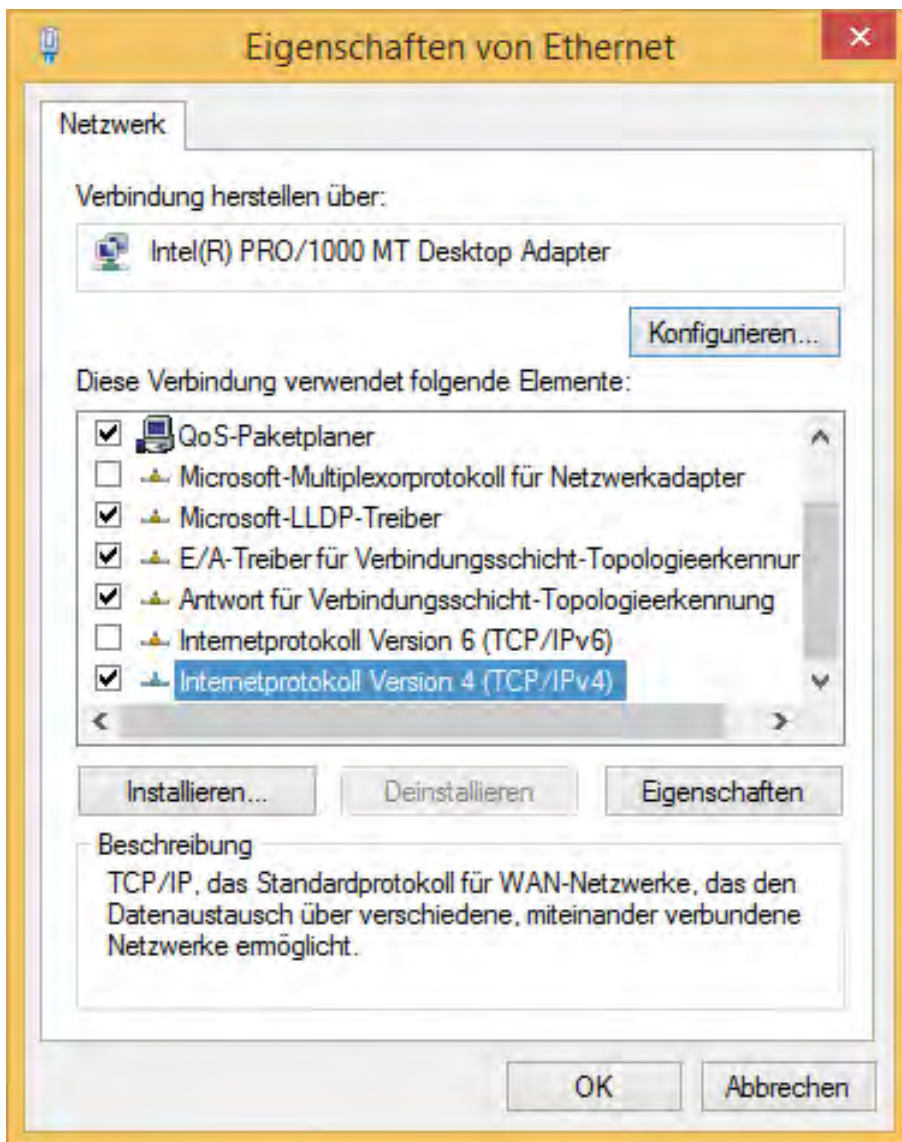

Fig. 26: Network settings on Windows machines

1. Open the Windows **Control Panel > Network and Internet > Network and Sharing Center > Change Adapter Settings > Ethernet**.
2. Right-click on the relevant network adapter and select **Properties**.

3. Open the properties of **Internet Protocol Version 4 (TCP/IPv4)**.

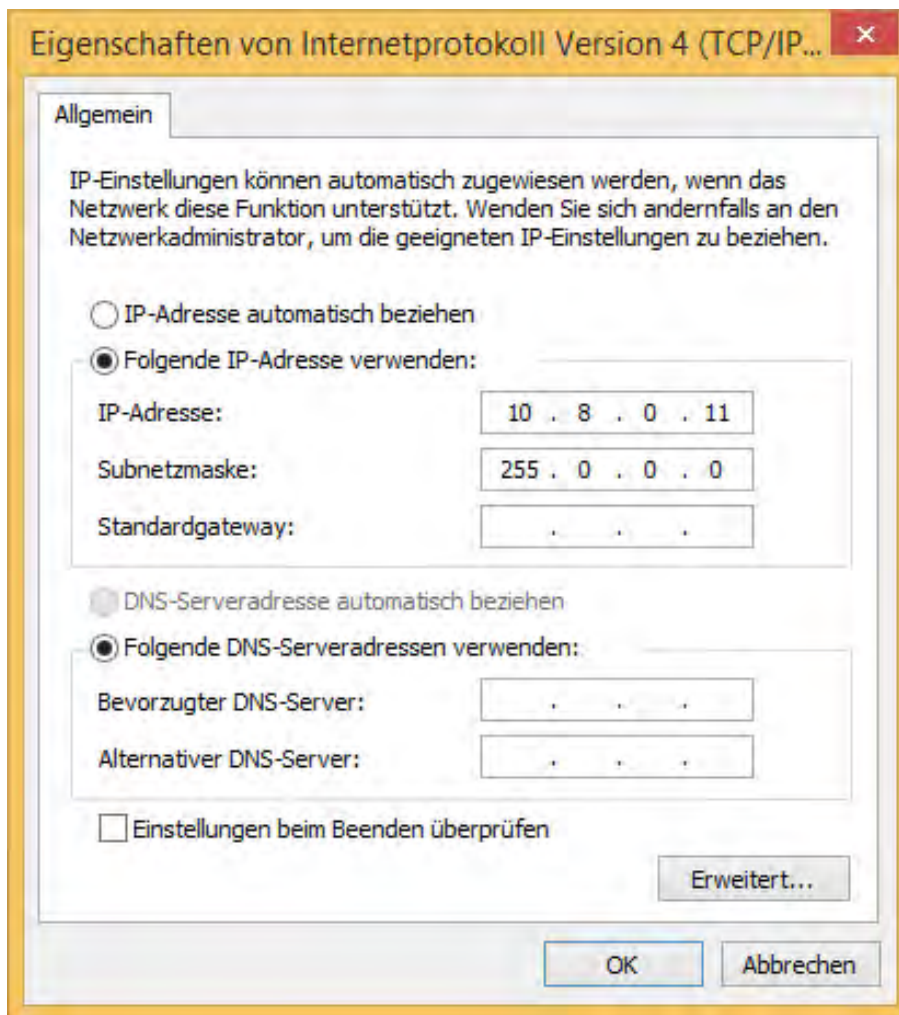

Fig. 27: Properties of Internet Protocol V4

4. Activate **Use the following IP-address**. Enter an IP address in the 10.x.x.x range in this field (e.g. 10.16.0.11).
5. Click on **OK** to apply the settings.

Linux/Unix

1. Open a terminal as `root` user.
2. Enter the following command: `ifconfig eth0:1 10.16.0.11`.
3. The computer now has the additional IP address 10.16.0.11.

macOS

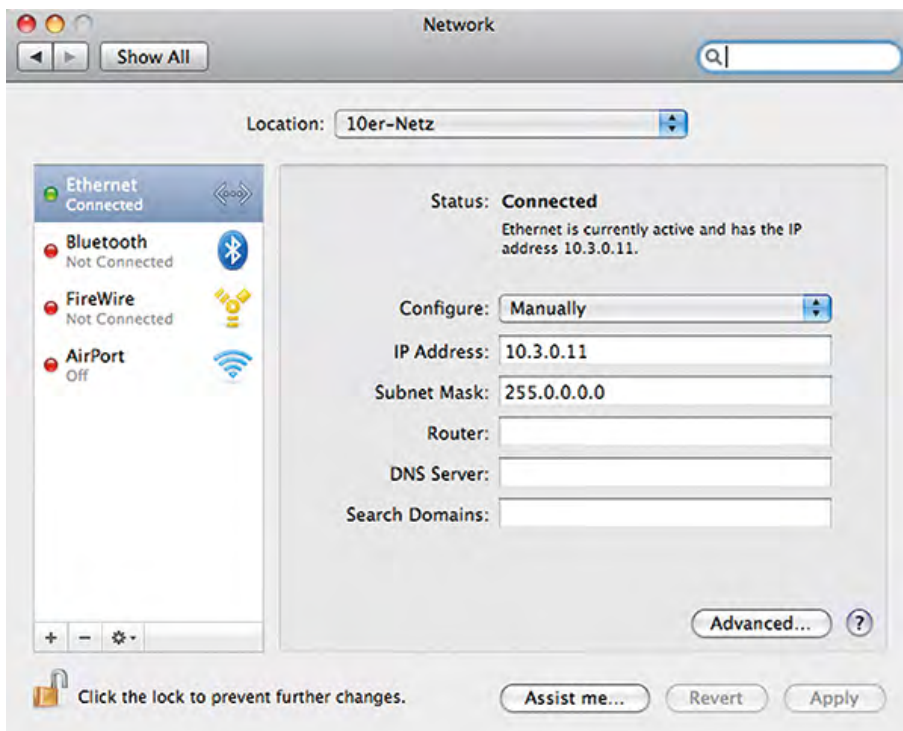

Fig. 28: Network settings on macOS machines

1. Open **System Settings > Network**.
2. Click on **Ethernet** and in the **Configuration** field, select the *Manual* list entry and enter an IP address in the 10.x.x.x IP address range (e.g., 10.16.0.11).
3. Click on **Apply** to apply the settings.

MOBOTIX Camera in the Browser

Quick Installation

Ethernet Interface

Assign a unique **IP address** and the **network mask** to the camera. These values consist of four numbers (0 to 255) separated by dots. They define which other IP addresses can be reached directly on your LAN. In order to access the camera from your computer via LAN, your computer needs an IP address on the same subnet as the camera.

If unsure, ask your system administrator for a valid and unique IP address and the network mask of your subnet.

Camera IP Address:

Camera Network Mask:

Fig. 29: Network settings in the web interface of the camera

1. Use a web browser to access the web interface of the MOBOTIX camera and enter the factory IP address (e.g., 10.16.0.99).
2. Click on the **Admin Menu** button in the user interface of the camera. The Quick Installation automatically starts after entering the access credentials of the admin user.

Factory access credentials:**User name:** admin**Password:** meinsm**Note**

You can also run the Quick Installation later on (**Admin Menu > Network Configuration > Quick Installation**; see Reference Manual).

3. **Enter the network parameters of the camera in the course of the quick installation.**

Note

You can also change the network parameters later on by running **Admin Menu > Network Configuration > Quick Installation**.

4. Reboot the camera to apply the network settings.

MOBOTIX Camera in MxManagementCenter

MxManagementCenter is a video management software for setting up and using the entire video surveillance system that provides a range of functions for different tasks and user groups. You can download the newest release of MxManagementCenter from the MOBOTIX website (www.mobotix.com > Support > Download Center > Software Downloads, MxManagementCenter section).

Please refer to the MxManagementCenter help for more information.

Procedure

When starting MxManagementCenter for the first time, the configuration wizard opens and automatically starts searching for MOBOTIX cameras. The number of found cameras is shown as a counter next to the **Add Devices** icon . This number is updated automatically if the number of MOBOTIX cameras on the network has changed (i.e., by connecting new/disconnecting existing cameras).

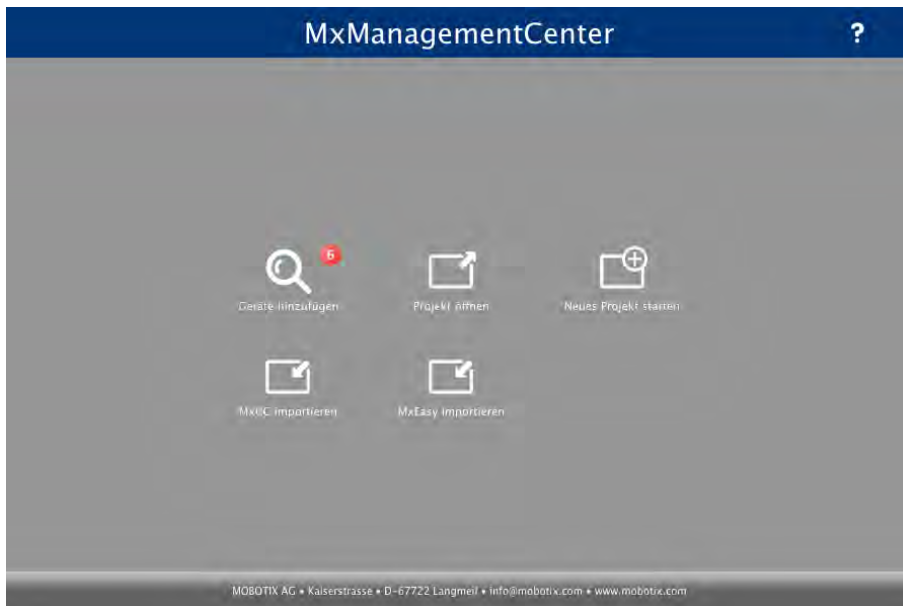

Start screen of the MxManagementCenter

1. Click on **Add Devices**. The cameras are displayed either in a list or as tiles. Use the List and Tile buttons to change the display mode.



Fig. 30: Cameras as list

The application automatically monitors and displays the operating status of all cameras using corresponding icons. Example:

- The camera is not in the same subnet as the computer.
- The user name and password of the camera are not known.

Note

Using the Bonjour service ([en.wikipedia.org/wiki/Bonjour_\(software\)](https://en.wikipedia.org/wiki/Bonjour_(software))), the application finds not only MOBOTIX cameras on the same subnet, but also in other subnets. Normally, you would not be able to establish any connection to cameras in a different network or subnet.

Note

This is the case, for example, if you are integrating cameras into a network without DHCP server (i.e., with fixed IP addresses) and the IP address range is different from the 10.x.x.x range supported by the cameras in addition to DHCP.

MxManagementCenter can automatically configure such a camera so that it is "integrated" into your existing network.

2. Select the camera you want to set up and click on **Edit Network Settings**  at the bottom of the program window. The **Change Network Settings for Selected Devices** dialog opens.

Fig. 31: Change network settings for selected devices

3. Enter the IP address and the subnet mask of the selected camera.

Note

The IP addresses of the other cameras are automatically incremented by 1.

4. Click on **Apply** to apply the settings.

Note

For more information on this feature, please read the MxManagementCenter online help or the Tutorial (see www.mobotix.com > Support > Download Center > Documentation > Brochures & Guides > Tutorials).

Focusing the TELE 15° Sensor Module

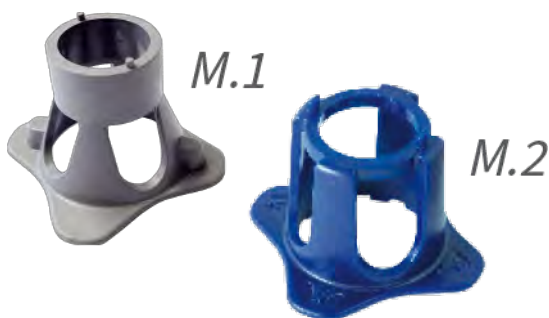

Fig. 32: Module wrench MOBOTIX S74: Scope of Delivery, p. 14 and lens wrench MOBOTIX S74: Scope of Delivery, p. 14 of the S74

Operating the Camera

Focusing the TELE 15° Sensor Module

Once the camera has been mounted, the **TELE 15° sensor module** should be checked for proper sharpness. You will need the **lens wrench blue M.2** and the **module wrench gray M.1** that are part of the **MOBOTIX S74: Scope of Delivery**, p. 14.

When adjusting the image focus or the field of view of the camera, always make sure that you can see the live image of the camera!

To correct image sharpness, you can also make use of the visual **focusing aid** of the camera (see the **Camera Reference Manual**, section **The Live View of the MOBOTIX Camera**)

Focusing the Camera Lenses

1. Show the live image of the camera on your monitor.
2. Insert the blue lens wrench into the notches of the sensor module.
3. Turn the wrench counter-clockwise until it stops:

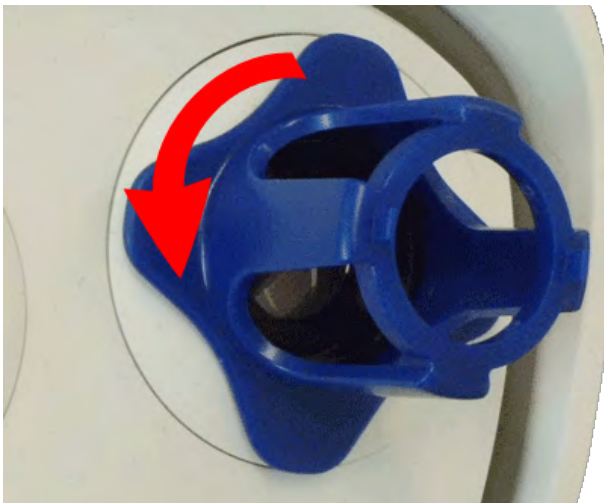

Fig. 33: Turn sensor module counter-clockwise until it stops

Caution:

If the red security clips M.14 have not been installed, the sensor module will also rotate! If this happens, keep on turning until the sensor module stops in its position for removal.

4. Rotate the wrench to the left until the lens protection glass slides out of the sensor module.

- 5. Insert the gray module wrench (with its two small pins) into the holes of the lens and cautiously turn to the left and to the right. Adjust the image sharpness according to the live image on the computer monitor:

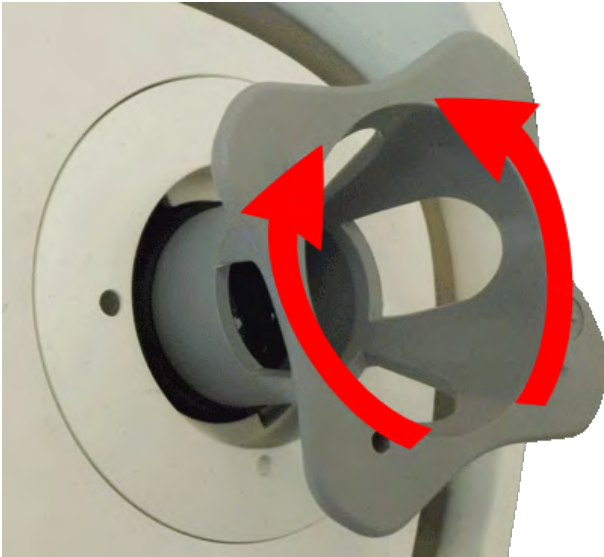

Fig. 34: Adjust lens focus

Caution:
Never apply force when turning the lens and never screw the lens too deep into the thread since this could damage the image sensor! If in doubt, keep turning the lens counter-clockwise, then turn clockwise to focus the lens.

- 6. If required, clean the inside of the lens protection glass with a clean, lint-free cloth:



Fig. 35: Lens protection glass

Operating the Camera

Focusing the TELE 15° Sensor Module

7. Set the lens protection glass onto the notches of the blue lens wrench and position the protection glass with its two prongs over the corresponding receptacles of the sensor module:

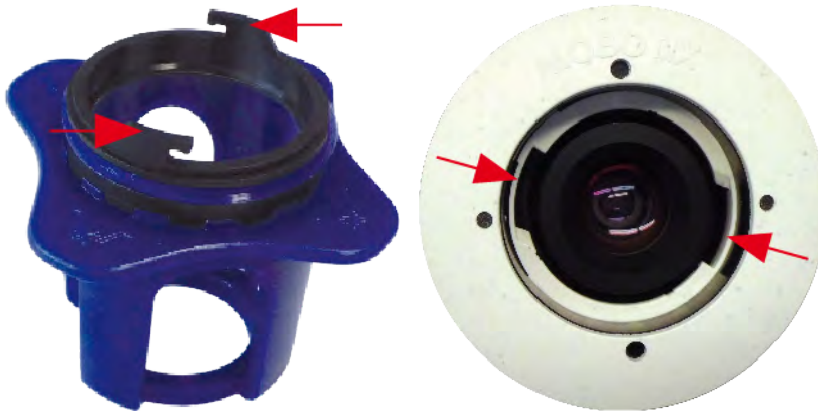

Fig. 36: Insert lens protection glass using the lens wrench

8. Using the lens wrench, press the lens protection glass firmly into the sensor module, until the glass fits flush with the sensor module housing.



Fig. 37: Push hard to insert lens protection glass and turn to lock

9. Turn the lens protection glass clockwise using the blue lens wrench until it locks in place.
10. If required, clean the outside of the lens protection glass with a clean, lint-free cloth:

Note:

After adjusting the focus, make sure that the sensor module is aligned properly and that it is locked in place (use the gray module wrench to turn the sensor module clockwise until it stops).

Camera Software in the Browser

The integrated software of the S74 features a multitude of functions, such as video motion detection, long-term recording, alarm messaging and video IP telephony. Especially remarkable are the AI-based analytics features and the possibility to install third-party apps on the camera. Thanks to the virtual PTZ features, you can continuously zoom into or out of the live image using either the mouse wheel or a joystick.

When recording images or video sequences, you can choose to store either the visible image area of the live image or the full sensor image. This also allows examining the parts of an image or video that had not been visible in the real-time image section on display at the time of the recording.

Instead of using a web browser, you can also download the free MxManagementCenter from the MOBOTIX website, which allows displaying multiple cameras on one monitor, allows for comfortably searching and evaluating the alarm video clips with audio and provides alerting features (www.mobotix.com > Support). For mobile iOS and Android devices, the free-of-charge MOBOTIX MxBell is available.

Once the power and network connection of the MOBOTIX have been established, you can open the interface of the camera software in a web browser.

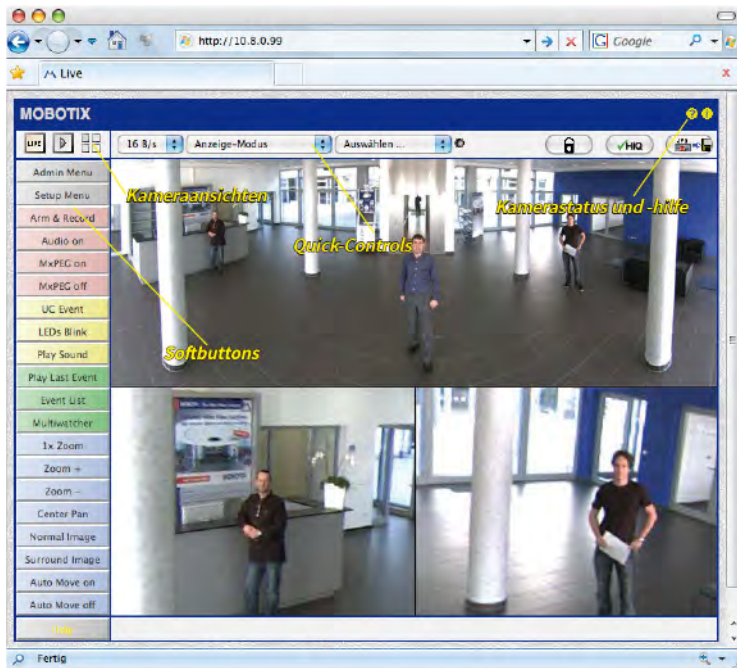

Fig. 38: The interface of the camera software

Default access credentials for the Administration Menu:

User name: admin

Password: meinsm

You must change the password when logging in for the first time

Open the camera's website in the browser

1. Enter the camera's IP address in the address field of a web browser.

Note

Make sure to copy the IP address camera from the back of the camera housing or from the sticker 1.12.

Basic Settings

Password for the Administration Menu: Accessing the administration area of the camera (Admin Menu button) in the browser is only possible after entering a user name and password.

- **Default user name:** admin
- **Default password:** meinsm

Note

You must change the password when logging in for the first time.

Make sure that you store information on user names and passwords in a secure place. If you lose the administrator password and cannot access the Administration menu, the password can only be reset at the factory. This service is subject to a service charge.

The Quick Installation wizard will appear automatically when accessing the Administration Menu for the first time. It provides an easy method to adjust the basic camera settings to the current application scenario. For security reasons, it is highly recommended to change the default administrator password after the camera has been configured properly.

Enter the user name and password exactly as shown above. Note that all entries are case-sensitive.

Administering the camera: You can modify the camera configuration in the Administration Menu or the Setup Menu:

- **Admin Menu:** This menu contains the basic configuration dialogs of the camera (e.g. passwords, interfaces, software update).
- **Setup Menu:** This menu contains the dialogs for configuring the image, event and recording parameters. Some of these settings can be changed using the corresponding Quick Controls in the Live screen.

For more information, please consult the Reference Manual of the camera.

Configuring Sensor Modules

Using different combinations of sensor modules of the MOBOTIX S74 will have an influence on the display modes and configuration variants that are available.

An S74 will automatically check and verify the installed sensor modules upon its first start and at every reboot thereafter (e.g., focal length, Day or Night variant). Please note the following:

- If only one sensor module is attached, the camera will behave like a mono camera (i.e., there is no automatic Day/Night switching).
- If the modules are not exchanged within the first 12 operating hours, the camera will store the information of new sensor modules in the camera configuration.
- The camera will check the configuration on every reboot to see if the stored sensor modules are still present. If changes of the sensor module configuration have been detected (e.g., if a sensor module had to be replaced), the camera will show a corresponding message in the live image.

If required, the module configuration can be adjusted, e.g. you can define in which camera image (left or right) the sensor module should be displayed in a double image display.

Note on Using a Thermal Module

If you have installed the *Thermal Sensor Module* (see [Installing a Thermal Front Plate](#)), it is **mandatory to open the dialog below** and to set one of the image sensors (left or right) to **M3 (Thermal Sensor)**! If you do not see a thermal image on one of the sensors, you did not complete this step.

Open the **Admin Menu > Image Sensor Configuration** dialog:

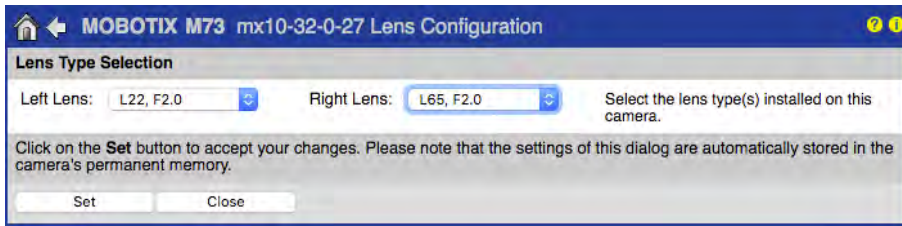

Fig. 39: Configuring the Sensor Modules

Open the **Image Sensor Configuration** dialog in the following cases:

- **Switching the displayed camera images:** You want to show the left-hand camera image on the right (and vice versa), without having to physically swap the module connectors at the camera itself.
- **Exchanging sensor modules:** In this case, the S74 will display a message box and will log a system message to inform you that sensor modules have been exchanged (see also [Installing the Sensor Modules to the Thermal Front Plate](#)).
- **Adding/activating sensor modules:** You can activate modules that had been deactivated before.
- **Switching off/removing sensor modules:** If required, you can deactivate connected modules in this dialog.

For more information, please consult the Reference Manual of the camera.